



## FLP Lens Series for LUXEON™ Rebel and Rebel ES LEDs

- High efficiency
- Available in 5 different beams
- Easy assembly

The FLP lens series offers four lenses specifically designed for the Lumileds<sup>1</sup> LUXEON® Rebel and Rebel ES LEDs.

The software-optimized aspheric profile combined with shaped front surfaces and micro-lenses provides several different output patterns: narrow, medium, wide, medium elliptical and wide elliptical beams<sup>2</sup>.

The high collection efficiency reaches up to 85% of the total flux emitted from the LED.

Lens holders are available to provide the proper alignment between the LEDs and the lenses.

The lens holder can be secured to the PCB using screws or glue for attachment.

Typical applications are:

- Reading lamps
- Architectural lighting
- Entertainment lighting
- Interior lighting
- Portable lighting



- (1) LUXEON® Rebel and Rebel ES are trademarks of Philips Lumileds. For technical specification on LEDs please refer to the LUXEON® Rebel and Rebel ES datasheet or visit [www.philipslumileds.com](http://www.philipslumileds.com)
- (2) Typical beam divergence may change with different color LEDs.

**FRAEN CORPORATION**  
80 Newcrossing Road  
Reading MA 01867  
USA  
Phone: +1 781.205.5300  
Fax: +1 781.942.2426

**FRAEN Srl**  
Via Stelvio, 12  
20019 Settimo M. (MI)  
Italy  
Phone: +39-02-35.456.1  
Fax: +39-02-335.456.239

Inquiries: [optics@fraen.com](mailto:optics@fraen.com)  
Website: [www.fraenomq.com/](http://www.fraenomq.com/)

Distributed by Future Electronics



**Americas: 1-888-LUXEON2**  
[askluxeon@FutureElectronics.com](mailto:askluxeon@FutureElectronics.com)  
**Europe: 00-0800-44FUTURE**  
[luxeon.europe@FutureElectronics.com](mailto:luxeon.europe@FutureElectronics.com)  
**Asia: 1-800-LUMILEDS**  
[lumileds.asia@FutureElectronics.com](mailto:lumileds.asia@FutureElectronics.com)



## General Characteristics

---

Lens Material	Optical Grade PMMA
Holder Material	PC/ABS
Operating Temperature range	-40deg C / + 95 deg C
Storage Temperature range	-40deg C / + 95 deg C

Average transmittance in visible spectrum (400 – 700nm) >90%, as measured using 3mm thick Optical Grade PMMA.

*Please note that flow lines and weld lines on the external surfaces of the lenses are acceptable if the optical performance of the lens is within the specification described in the section “OPTICAL CHARACTERISTICS”*

### IMPORTANT NOTE – Lenses handling and cleaning:

- Handling: Always use gloves to handle lenses and/or handle the lenses only by the flange. Never touch the outside surfaces of the lenses with fingers; finger oils and contamination will absorb or refract light.
- Cleaning: Clean lenses only if necessary. Use only soap and water to clean the surfaces and lenses. Never expose the lenses to alcohol, as it will damage the plastic.

## Scope

---

This datasheet provides information about the FLP series lenses for the Rebel and Rebel ES:





- FLP-N4-RE-0R
- FLP-M4-RE-0R
- FLP-W4-RE-0R
- FLP-E4-RE-0R
- FLP-E5-RE-0R

and lens assemblies:

<u>Black Holder</u>	<u>White Holder</u>	<u>Transparent Holder</u>
• FLP-N4-RS-HRF	FLP-N4-RS-HRFW	FLP-N4-RS-HRFT
• FLP-M4-RS-HRF	FLP-M4-RS-HRFW	FLP-M4-RS-HRFT
• FLP-W4-RS-HRF	FLP-W4-RS-HRFW	FLP-W4-RS-HRFT
• FLP-E4-RS-HRF	FLP-E4-RS-HRFW	FLP-E4-RS-HRFT
• FLP-E5-RS-HRF	FLP-E5-RS-HRFW	FLP-E5-RS-HRFT







## Optical Characteristics – Beam Angle (degrees, FWHM)<sup>1</sup>

Lens Part Number	Beam Shape	Red, Orange, Amber 	Green 	Cyan Blue 	Rebel Cool White 	Rebel ES Cool White 
FLP-N4-RE-0R	Narrow	9°	9°	11°	9°	13°
FLP-M4-RE-0R	Medium	23°	23°	23°	21°	21°
FLP-W4-RE-0R	Wide	41°	40°	36°	39°	38°
FLP-E4-RE-0R	Wide Elliptical	11° x 44°	11° x 41°	11° x 44°	12° x 44°	16° x 40°
FLP-E5-RE-0R	Medium Elliptical	10° x 23°	11° x 24°	10° x 23°	10° x 23°	13° x 24°

(1) FWHM is the full angle where the beam intensity is half the on-axis peak intensity

## Optical Characteristics – On-Axis Intensity (candela/lumen)<sup>2,3,4</sup>

Lens Part Number	Beam Shape	Red, Orange, Amber 	Green 	Cyan Blue 	Rebel Cool White 	Rebel ES Cool White 
FLP-N4-RE-0R	Narrow	22	24	15	24	13
FLP-M4-RE-0R	Medium	4	4	4	4	4
FLP-W4-RE-0R	Wide	2	2	2	4	2
FLP-E4-RE-0R	Wide Elliptical	5	5	4	5	3
FLP-E5-RE-0R	Medium Elliptical	9	9	6	9	7

- (2) To calculate the on-axis intensity, multiply the on-axis efficiency of the lens (cd/lm) by the total flux of the Luxeon LED used. See “Illumination Calculations” below. For more detail on flux binning please check the Luxeon LED datasheet at [www.philipslumileds.com](http://www.philipslumileds.com)
- (3) Luminous intensity depends on the flux binning and tolerances of the LEDs. Please refer to the Luxeon datasheet for more details on flux binning and mechanical tolerances.
- (4) Typical illuminance measured in lux per lumen (E) with typical Luxeon™ LEDs. To estimate the illuminance in lux, multiply the typical illuminance E by the flux in lumen of the LED used. See “Illumination Calculations” below



## Illumination Calculations

---

To calculate peak candela: Find the central spot “on-axis intensity” value in the table above, then multiply this value by the lumens output from your LED (refer to the Luxeon Rebel or Rebel ES LED datasheet) for nominal lumens values. For a more accurate calculation, refer to the intensity “ranking” (binning) tables on the datasheet for the specific LED.

Example calculations:

If the Fraen narrow beam lens FLP-N4-RE-0R is used on a cool white Luxeon Rebel LED at 350 mA, the typical luminous flux of the LED is 80 lumens:

The calculation is: (24 candela/lumen) x (80 lumens) = 1920 candela peak on-axis.

The beam angle specified in the table above is 9 degrees FWHM (full angular width measured where the beam intensity equals half the on-axis maximum intensity.) This means at 4.5 degrees off-axis (half of 9 degrees), the intensity should be half of 1920 candela, or 960 candelas.

1 candela at 1-meter distance produces 1 Lux. This means the peak intensity at 1 meter will be 1920 lux. The intensity decreases as a function of the distance squared, so at 2 meters the peak intensity will be  $1920 / (2^2) = 480$  lux. At 3 meters distance, the peak intensity will be  $1920 / (3^2) = 213$  lux.

## Mechanical Characteristics

---

**Figure 1. Identifying the lenses by their front views**

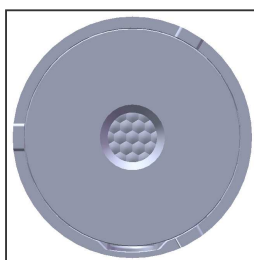

FLP-N4-RE-0R

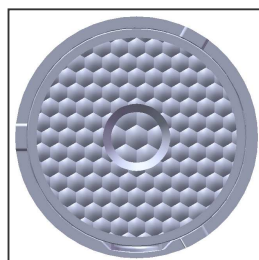

FLP-M4-RE-0R  
Microlenses are textured

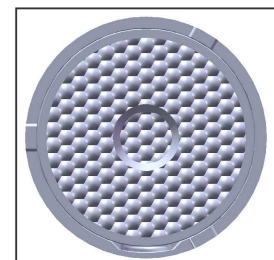

FLP-W4-RE-0R  
Microlenses are polished



FLP-E4-RE-0R  
Lens has 11 ridges



FLP-E5-RE-0R  
Lens has 10 ridges



The FLP series lenses are available either assembled with a holder or as a lens alone. The holder provides the correct alignment (concentricity, height, and orientation) of the lens to the LED. Orientation control is important for the elliptical beam lens.

**Figure 2. Correct vertical position of the FLP lens and Luxeon Rebel/Rebel ES LEDs**

**NOTE:** If the FLP lens is used with no lens holder, the user must provide a mechanical method to set the correct position of the lens on the LED. For example, the lens flange can be located in the lamp housing to center the lens to the LED and establish 10.8 mm from the lens flange to the user's PC board. When the lens is positioned correctly, the bottom of the lens is the same height as the top of the LED rectangle substrate, and concentric with the LED dome lens, as shown below.

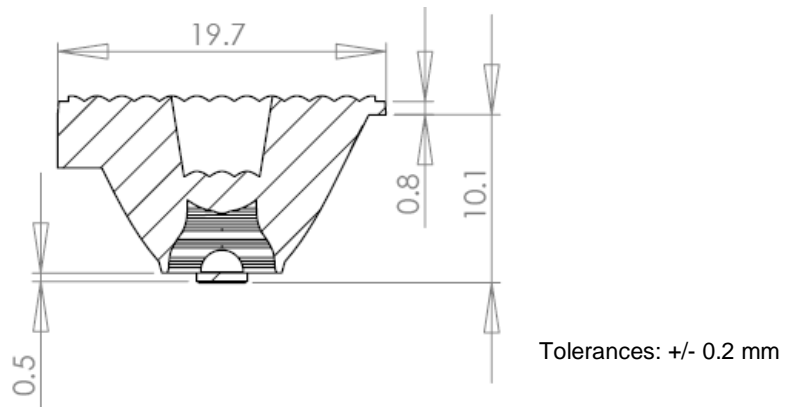

FLP-\_4-RE-0R

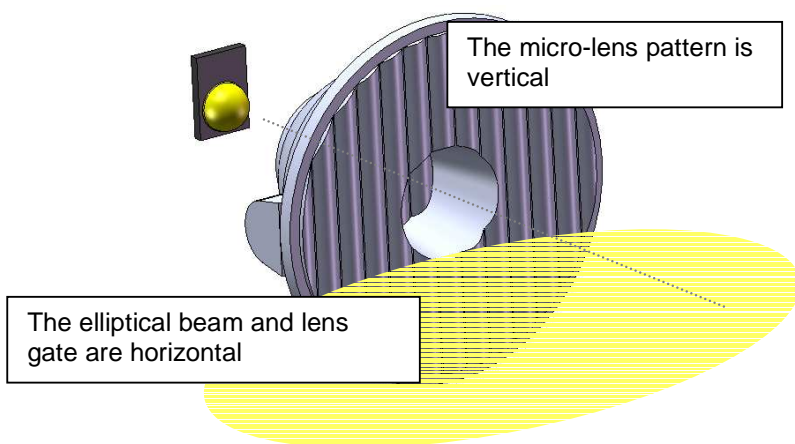

**NOTE:** The elliptical beam lens produces a beam shape that is perpendicular to the microlens pattern on the output face of the lens. The lens holder is designed to align the elliptical pattern with the shorter dimension of the Rebel/Rebel ES LED. It is important to consider the orientation of the LEDs and the desired elliptical beam orientation when designing the printed circuit board layout.

**Figure 3. Elliptical beam orientation**



**Figure 4. Installation of lens assembly onto Luxeon Rebel/Rebel ES LED**

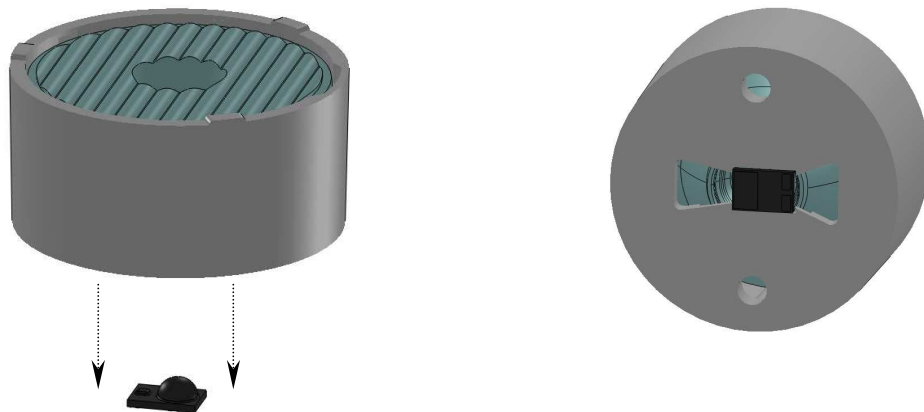

The FLP-E4-RS-HRF (and N4, M4 and W4) lens assemblies will fit onto the Luxeon Rebel/Rebel ES LED at only 1 orientation. The bottom of the –HRF lens holder is shaped to control lens orientation (important for “E4” elliptical beam lens application). After installation, the bottom of the holder should be at the same datum/plane as the bottom of the Rebel/Rebel ES LED.

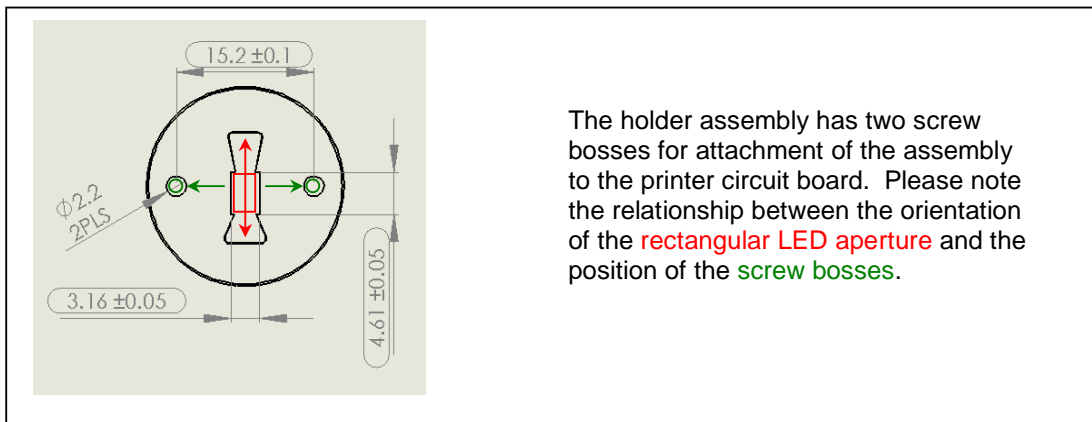

**Fig. 5. Relationship between the screw bosses and LED aperture**

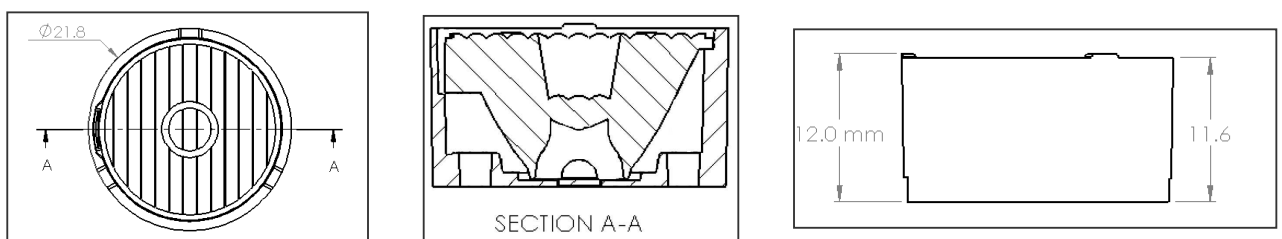

**Fig. 6. Holder Assembly: Top, Section and Side views**



## Ordering part numbers

### For lens only (no holder)

**Caution:** if using lens alone, the user must set lens alignment and spacing. See Figure 2.

**FLP- \_4-RE-0R**

N: Narrow beam  
M: Medium beam  
W: Wide beam

**FLP-E \_-RE-0R**

4: 12° x 44° Wide Elliptical (Rebel Cool White, other colors may differ)  
5: 10° x 23° Medium Elliptical (Rebel Cool White, other colors may differ)

### For assembly (lens + holder)

**FLP- \_4-RS-HRF** (Black Holder)  
**-HRFW** (White Holder)  
**-HRFT** (Transparent Holder)

N: Narrow beam  
M: Medium beam  
W: Wide beam

**FLP-E \_-RS-HRF** (Black Holder)  
**-HRFW** (White Holder)  
**-HRFT** (Transparent Holder)

4: 12° x 44° Wide Elliptical (Rebel Cool White, other colors may differ)  
5: 10° x 23° Medium Elliptical (Rebel Cool White, other colors may differ)

**Caution:** The orientation of the elliptical beam lens is controlled by the lens holder and the LED orientation (see Figure 3).

Published by Fraen Corporation.

All data contained in this document is the property of Fraen Corporation and may change without notice.

Rev	Date	Author	Description
00	11 April 2011	J. Gilbert	Initial Release.