

LUXEON Rebel
PC Amber

*High flux
and color stability*

Technical Datasheet DS62

L U X E N[®]
never before possible



LUXEON[®] Rebel

Phosphor-Converted (PC) Amber

Introduction

LUXEON[®] Rebel Phosphor-Converted (PC) Amber is an ultra-compact, surface-mount, high-power LED that delivers industry-leading standards for light output, color stability, flux density, color quality, and manufacturability. LUXEON Rebel PC Amber enables you to create never before possible lighting applications and:

- deliver more useable light, higher flux density, better color stability and light quality
- optimize applications to reduce size and cost
- tightly pack the LEDs for color mixing applications
- engineer more robust applications
- utilize standard FR4 PCB technology
- simplify manufacturing through the use of surface mount technology
- recognized under the Component Recognition Program of Underwriters Laboratories Inc. UL listing E327436.

PHILIPS
LUMILEDS

Table of Contents

Product Nomenclature.....	3
Average Lumen Maintenance Characteristics	3
Environmental Compliance.....	3
Visual Appearance of LUXEON Rebel.....	3
Flux Characteristics.....	4
Flux Performance, Binning, and Supportability	4
Optical Characteristics.....	5
Electrical and Thermal Characteristics.....	6
Absolute Maximum Ratings	7
JEDEC Moisture Sensitivity.....	7
Reflow Soldering Characteristics	8
Mechanical Dimensions	9
Pad Configuration.....	10
Solder Pad Design.....	10
Typical Wavelength Characteristics at Test Current.....	11
Typical Light Output Characteristics over Temperature.....	11
Typical Forward Current Characteristics	12
Typical Relative Luminous Flux	12
Typical Chromaticity Characteristics.....	13
Current Derating Curves.....	14
Typical Radiation Patterns.....	15
Emitter Pocket Tape Packaging.....	16
Emitter Reel Packaging	17
Product Binning and Labeling	18
Luminous Flux Bins.....	19
Color Bin Structure.....	20
Forward Voltage Bins.....	21

Product Nomenclature

LUXEON Rebel PC Amber is tested and binned at 350 mA, with current pulse duration of 20ms. All characteristic charts where the thermal pad is kept at constant temperature (25°C typically) are measured with current pulse duration of 20ms.

The part number designation is explained as follows:

L X M 2 - A B C D - E F G H

Where:

- A — designates radiation pattern (value P for Lambertian)
- B — designates color (see LUXEON Rebel Binning and Labeling section)
- C — designates color variant (0 for direct colored variants)
- D — designates test current (value I for 350 mA)
- EFGH — reserved for future product offerings

Therefore products tested and binned at 350 mA follow the part numbering scheme:

L X M 2 - P L 0 I - x x x x

Average Lumen Maintenance Characteristics

Lumen maintenance for solid-state lighting devices (LEDs) is typically defined in terms of the percentage of initial light output remaining after a specified period of time. Philips Lumileds projects that LUXEON Rebel products will deliver, on average, 70% lumen maintenance (L70) at 50,000 hours of operation at a forward current of up to 700 mA. This projection is based on constant current operation with junction temperature maintained at or below 130°C. This performance is based on independent test data, Philips Lumileds historical data from tests run on similar material systems, and internal LUXEON reliability testing. Observation of design limits included in this data sheet is required in order to achieve this projected lumen maintenance.

Environmental Compliance

Philips Lumileds is committed to providing environmentally friendly products to the solid state lighting market. LUXEON Rebel is compliant with the European Union directives EICC, RoHS, REACH, PFOS & PFOA, Halogen content, as well as California Proposition 65. Philips Lumileds will not intentionally add the following restricted materials to the LUXEON Rebel: lead, mercury, cadmium, hexavalent chromium, polybrominated biphenyls (PBB) or polybrominated diphenyl ethers (PBDE). For more information please visit www.philipslumileds.com.

Visual Appearance of LUXEON Rebel

All lighted LUXEON Rebel products will provide comparable Lambertian beam performance, suitable for use with commercially available optical systems. Without power, LED die within different reels may appear visually different. Please contact your Philips Lumileds or Future Electronics representative for further information.

Flux Characteristics

Flux Characteristics

Thermal Pad Temperature = 25°C

Table I.

Color	Part Number	Performance at Test Current			Typical Performance at Indicated Current	
		Minimum Luminous Flux (lm) ^[1]	Typical Luminous Flux (lm) ^[1]	Test Current (mA)	Typical Luminous Flux (lm) ^[2]	Drive Current (mA)
Amber	LXM2-PL01-xxxx ^[3]	50	75	350	132	700

Notes for Table I:

1. Minimum luminous flux performance guaranteed within published operating conditions. Philips Lumileds maintains a tolerance of $\pm 6.5\%$ on flux measurements.
2. Typical luminous flux performance when device is operated within published operating conditions.
3. Philips Lumileds LEDs are packaged and binned in 10lm flux increment identified by flux category codes. Each reel contains only one flux category code.

Flux Performance, Binning, and Supportability

LEDs are produced with semiconductor technology that is subject to process variation, yielding a range of flux performance that is approximately Gaussian in nature. In order to provide customers with fine granularity within the overall flux distribution, Philips Lumileds separates LEDs into fixed, easy to design with, minimum luminous flux bins. To verify supportability of parts chosen for your application design, please consult your Philips Lumileds or Future Lighting Solutions sales representative.

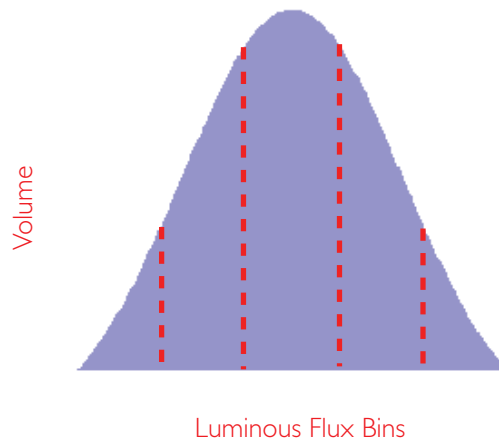

Optical Characteristics

LUXEON Rebel PC Amber at Test Current ^[1] Thermal Pad Temperature = 25°C

Table 2.

Color	Dominant Wavelength ^[2] λ_D			Typical Spectral Half-width ^[3] (nm) $\Delta\lambda_{1/2}$	Typical Total Included Angle ^[4] (degrees) $\theta_{0.90V}$	Typical Viewing Angle ^[5] (degrees) $2\theta_{1/2}$
	Min.	Typ.	Max.			
Amber ^[6]	588nm	591nm	592nm	80	160	120

Notes for Table 2:

1. Test current is 350 mA for all LXM2-PL01-xxxx products.
2. Dominant wavelength is derived from the CIE 1931 Chromaticity diagram and represents the perceived color. Philips Lumileds tests and bins LUXEON Rebel PC Amber by chromaticity x and y coordinates with a tolerance of ± 0.005 on x, y color coordinates.
3. Spectral width at $\frac{1}{2}$ of the peak intensity.
4. Total angle at which 90% of total luminous flux is captured.
5. Viewing angle is the off axis angle from lamp centerline where the luminous intensity is $\frac{1}{2}$ of the peak value.
6. LUXEON Rebel PC Amber product is built with Indium Gallium Nitride (InGaN).

Electrical and Thermal Characteristics

Electrical Characteristics at Test Current^[1]

Thermal Pad Temperature = 25°C

Table 3.

Color	Forward Voltage V_f at 350 mA Drive Current ^[2]			Typical Forward Voltage V_f at 700 mA Drive Current ^[2]	Typical Temperature Coefficient of Forward Voltage ^[3] $\Delta V_f / \Delta T_j$	Typical Thermal Resistance Junction to Thermal Pad (°C/W) $R\theta_{j-c}$
	Min.	Typ.	Max.			
Amber	2.55	3.05	3.51	3.20	-2.0 to -4.0	10

Notes for Table 3:

1. Test current is 350 mA for all LXM2 - PL01 - xxxx products.
2. Philips Lumileds maintains a tolerance of $\pm 0.06V$ on forward voltage measurements.
3. Measured between 25°C = T_j = 110°C at I_f = 350 mA.

Absolute Maximum Ratings

Table 4.

Parameter	Value
DC Forward Current (mA)	700
Peak Pulsed Forward Current (mA)	700
Average Forward Current (mA)	700
ESD Sensitivity	< 8000V Human Body Model (HBM) Class 3A JESD22-A114-E < 400V Machine Model (MM) Class 3A JESD22-A115-B
LED Junction Temperature	130°C
Operating Case Temperature at 350 mA	-40°C - 110°C
Storage Temperature	-40°C - 135°C
Soldering Temperature	JEDEC 020c 260°C
Allowable Reflow Cycles	3
Autoclave Conditions	121°C at 2 ATM 100% Relative Humidity for 96 Hours Maximum
Reverse Voltage (Vr)	See Note 2

Notes for Table 4:

1. Proper current derating must be observed to maintain junction temperature below the maximum.
2. LEDs are not designed to be driven in reverse bias.

JEDEC Moisture Sensitivity

Table 5.

Level	Floor Life		Soak Requirements	
			Standard	Conditions
	Time	Conditions	Time (hours)	
I	unlimited	≤ 30°C / 85% RH	168 + 5 / -0	85°C / 85% RH

Reflow Soldering Characteristics

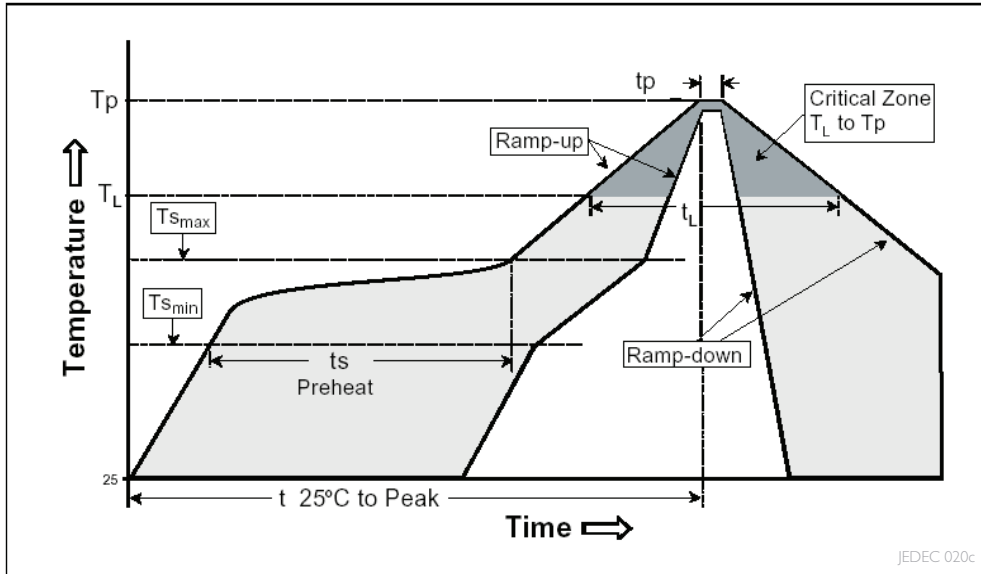

Table 6.

Profile Feature	Lead Free Assembly
Average Ramp-Up Rate ($T_{S_{max}}$ to T_p)	3°C / second max
Preheat Temperature Min ($T_{S_{min}}$)	150°C
Preheat Temperature Max ($T_{S_{max}}$)	200°C
Preheat Time ($t_{s_{min}}$ to $t_{s_{max}}$)	60 - 180 seconds
Time Maintained Above Temperature T_L (t_L)	217°C
Time Maintained Above Time (t_L)	60 - 150 seconds
Peak / Classification Temperature (T_p)	260°C
Time Within 5°C of Actual Peak Temperature (t_p)	20 - 40 seconds
Ramp-Down Rate	6°C / second max
Time 25°C to Peak Temperature	8 minutes max

Note for Table 6:

- I. All temperatures refer to the application Printed Circuit Board (PCB), measured on the surface adjacent to the package body.

Mechanical Dimensions

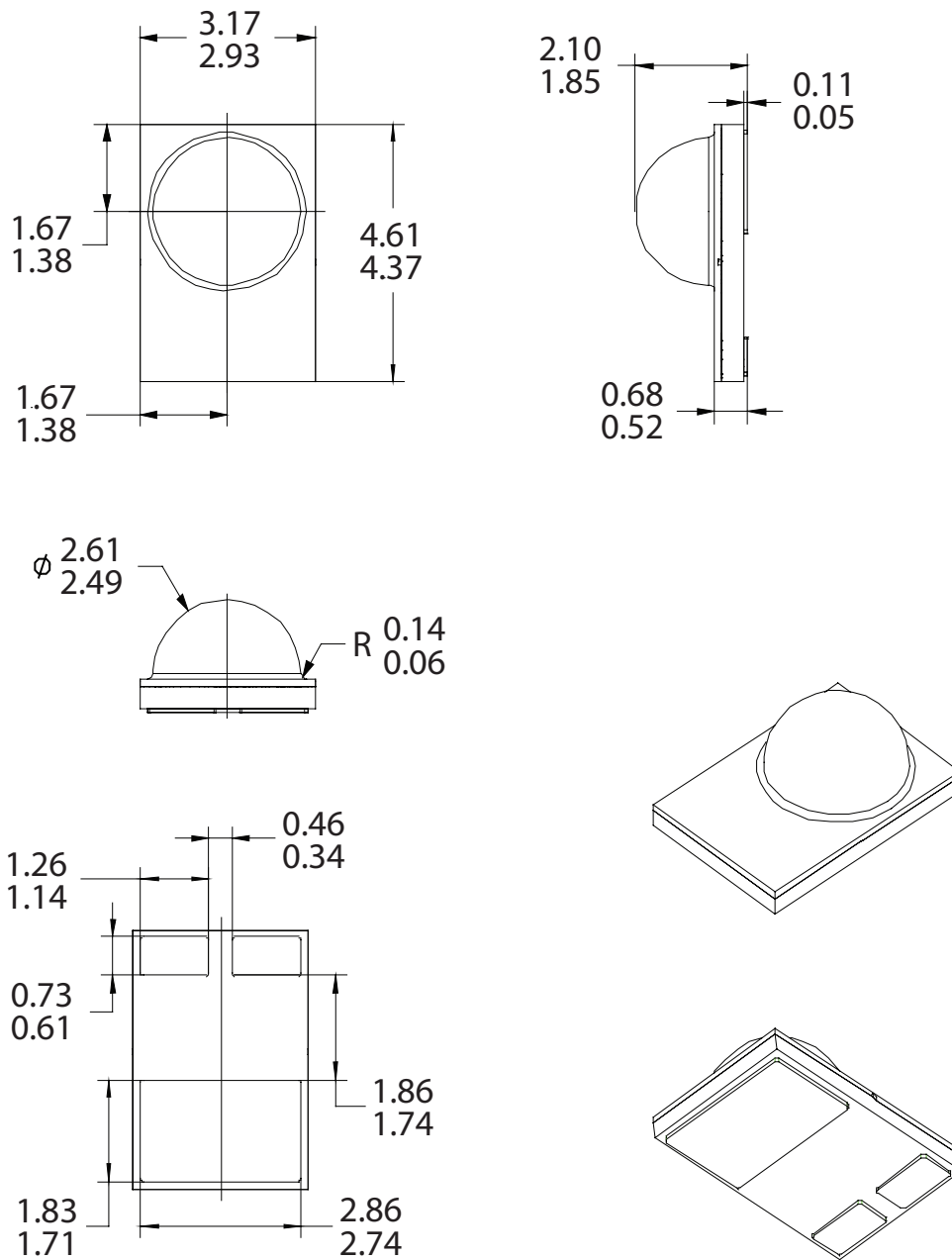

Figure I. Package Outline Drawing.

Notes for Figure I:

1. Do not handle the device by the lens—care must be taken to avoid damage to the lens or the interior of the device that can be damaged by excessive force to the lens.
2. Drawings not to scale.
3. All dimensions are in millimeters.
4. All dimensions without tolerances are for reference only.

Pad Configuration

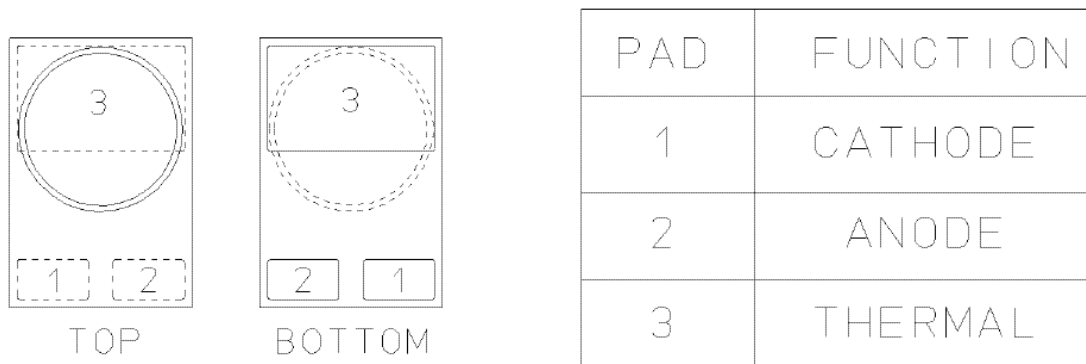

Figure 2. Pad Configuration.

Note for Figure 2:

1. The Thermal Pad is electrically isolated from the Anode and Cathode contact pads.

Solder Pad Design

Note for Figure 3:

The photograph below shows the recommended LUXEON Rebel layout on Printed Circuit Board (PCB). This design easily achieves a thermal resistance of 7K/W.

Application Brief AB32 provides extensive details for this layout. Additional design resources can be found at www.philipslumileds.com/resources.

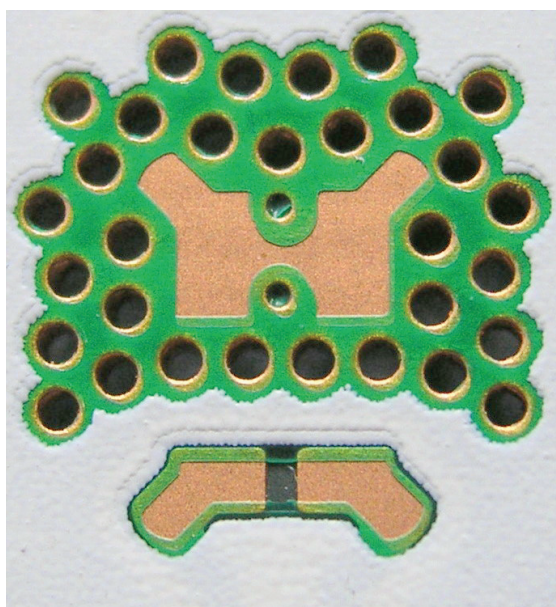

Figure 3. Solder Pad Layout.

Typical Wavelength Characteristics at Test Current Thermal Pad Temperature = 25°C

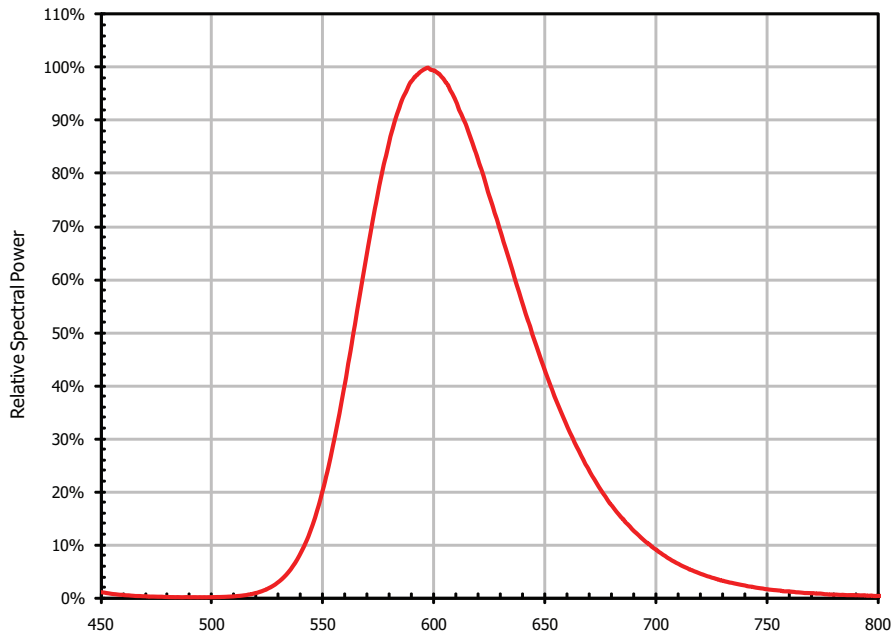

Figure 4. Relative Intensity vs. Wavelength.

Typical Light Output Characteristics over Temperature

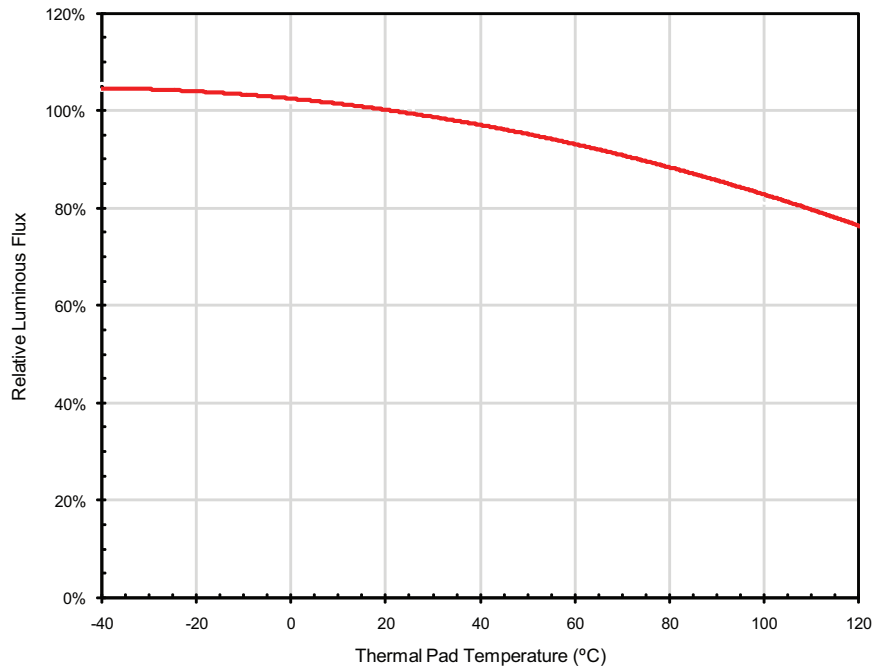

Figure 5. Relative Light Output vs. Thermal Pad Temperature.

Typical Forward Current Characteristics Thermal Pad Temperature = 25°C

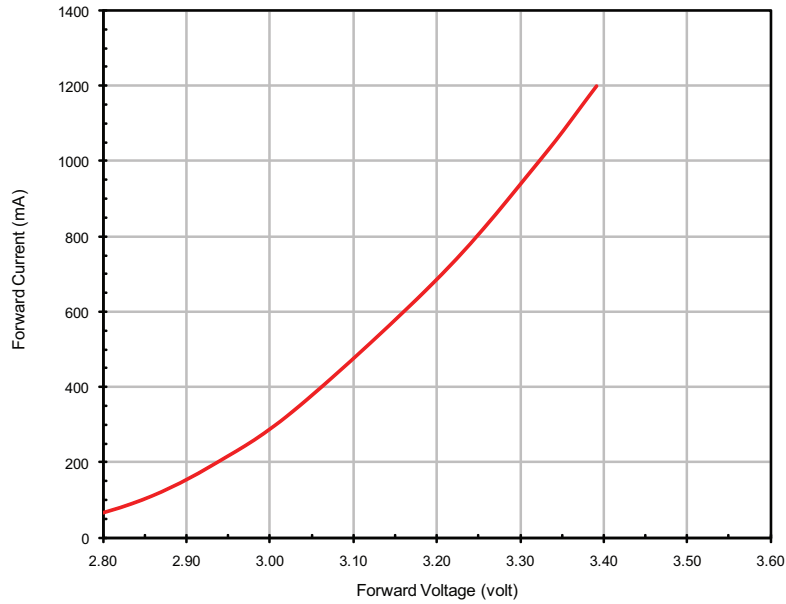

Figure 6. Forward Current vs Forward Voltage.

Typical Relative Luminous Flux Thermal Pad Temperature = 25°C

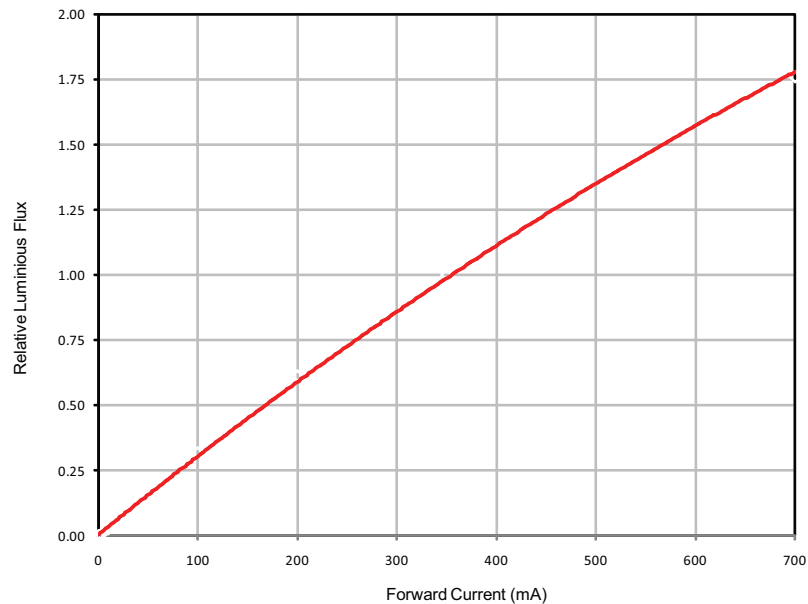

Figure 7. Relative Luminous Flux vs. Forward Current.

Typical Chromaticity Characteristics

Typical Chromaticity Characteristics over Temperature

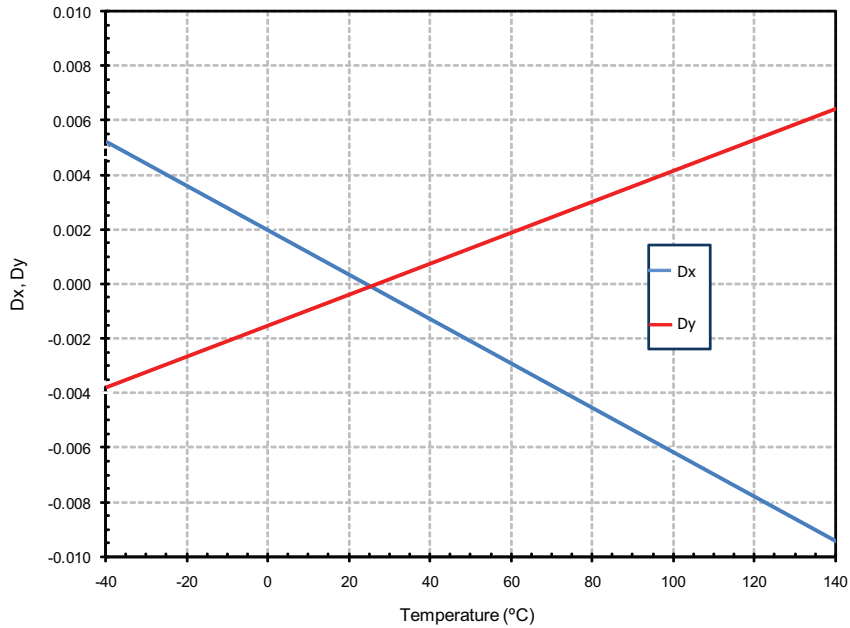

Figure 8a. Chromaticity Coordinate vs. Thermal Pad Temperature. Test current: 350 mA.

Typical Chromaticity Characteristics over Forward Current Thermal Pad Temperature = 25 °C

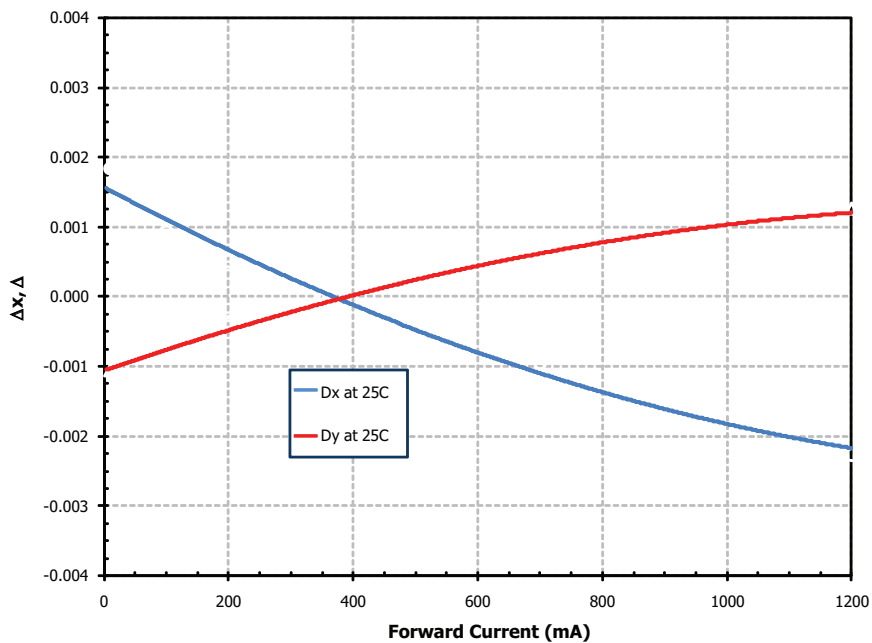

Figure 8b. Chromaticity Coordinate vs. Forward Current.

Current Derating Curves

Current Derating Curve for 350 mA Drive Current

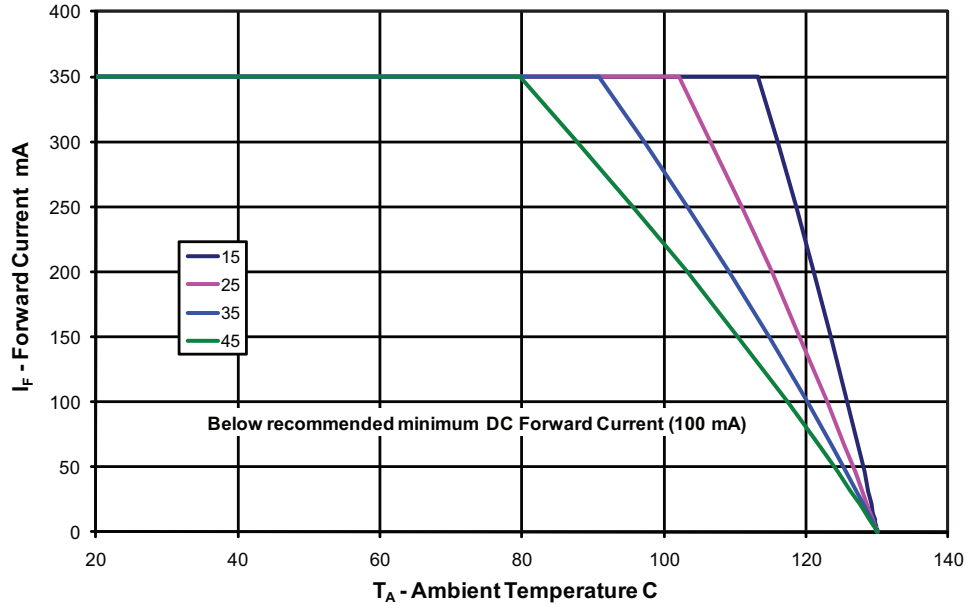

Figure 9a. Maximum Forward Current vs. Ambient Temperature, Based on $T_{JMAX} = 130^{\circ}\text{C}$.

Current Derating Curve for 700 mA Drive Current

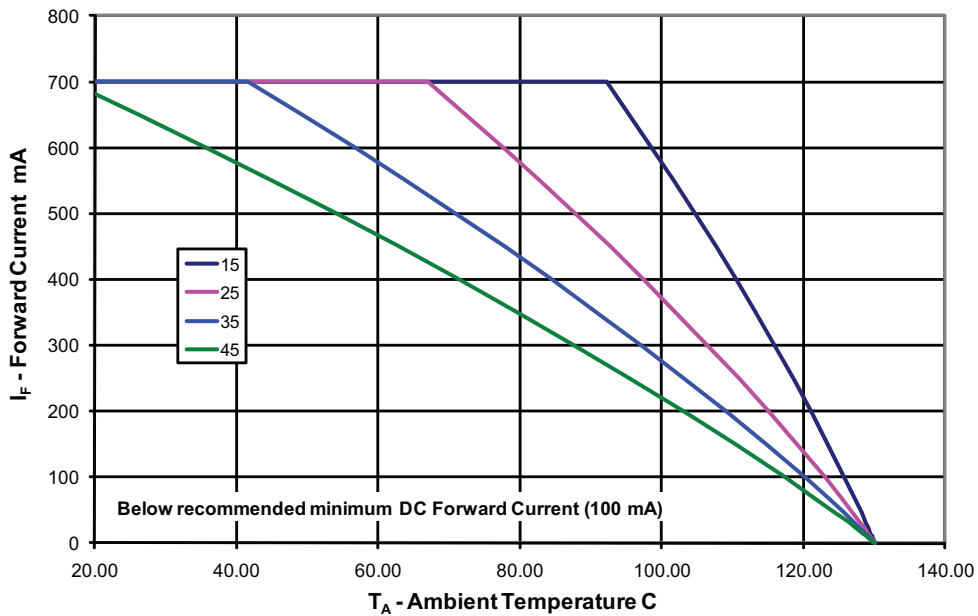

Figure 9b. Maximum Forward Current vs. Ambient Temperature, Based on $T_{JMAX} = 130^{\circ}\text{C}$.

Note for Figures 9a and 9b:

1. Current derating curves represent constant current operation condition.

Typical Radiation Patterns

Typical Spatial Radiation Pattern

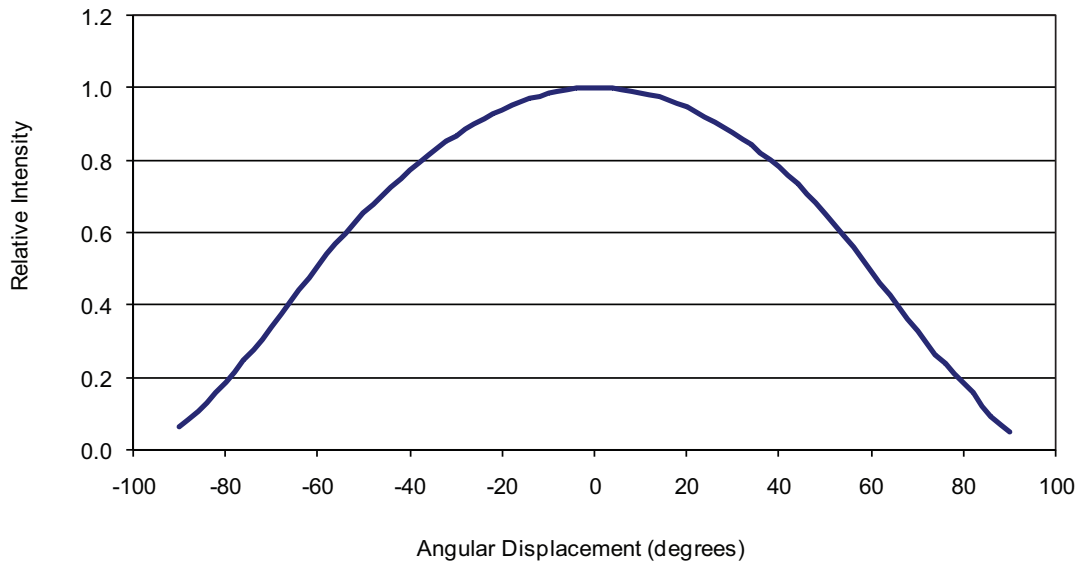

Figure 10a. Typical Representative Spatial Radiation Pattern.

Typical Polar Radiation Pattern

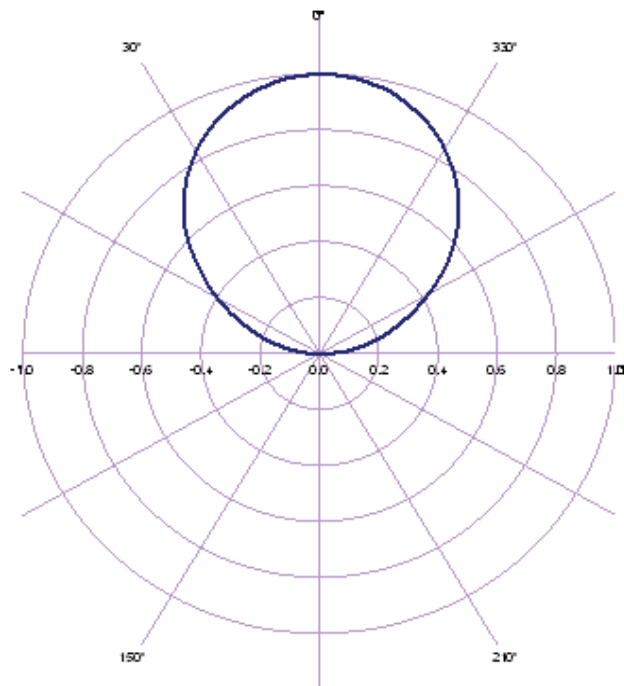

Figure 10b. Typical Polar Radiation Pattern.

Emitter Pocket Tape Packaging

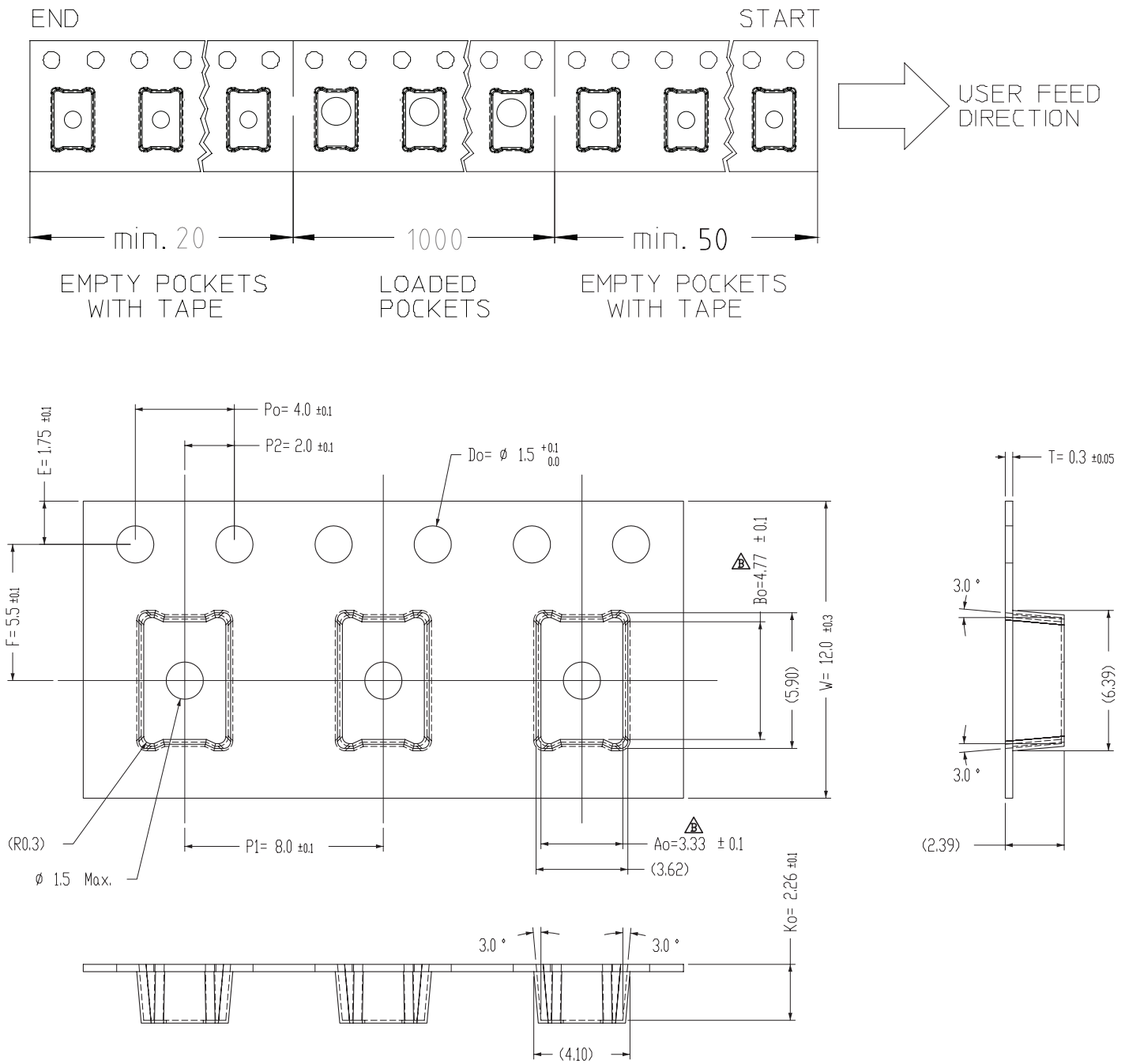
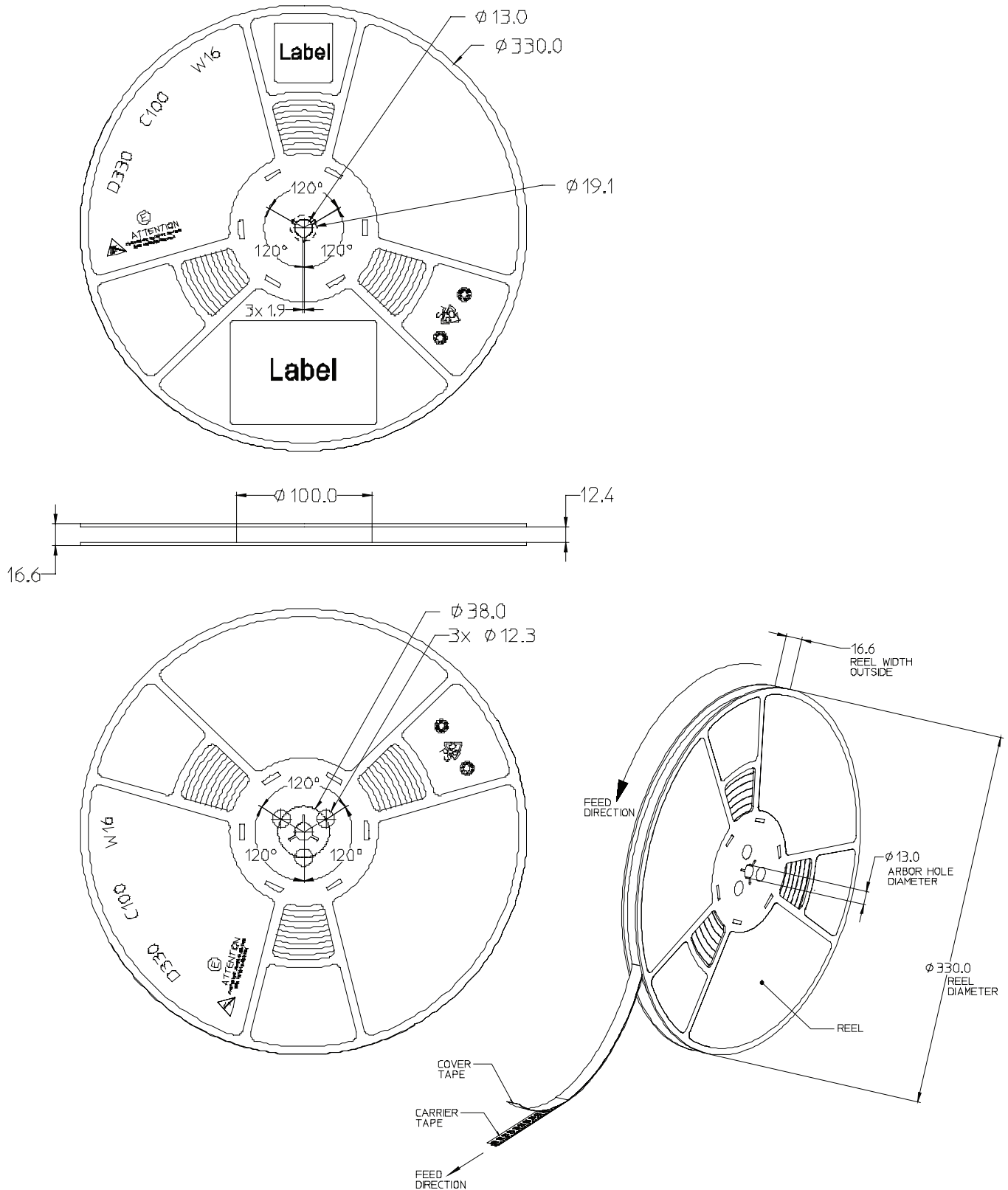

Figure 11. Emitter pocket tape packaging.

Emitter Reel Packaging

Standard Packaging Increment (SPI) is 1000 LEDs per 13" reel.



Product Binning and Labeling

Purpose of Product Binning

In the manufacturing of semiconductor products, there is a variation of performance around the average values given in the technical data sheets. For this reason, Philips Lumileds bins the LED components for luminous flux, color and forward voltage (V_f).

Decoding Product Bin Labeling

LUXEON Rebel Emitters are labeled using a three or four digit alphanumeric code (CAT code) depicting the bin values for emitters packaged on a single reel. Using these codes, it is possible to determine optimum mixing and matching of products for consistency in a given application.

Reels of PC Amber Emitters are labeled with a three digit alphanumeric CATcode following the format below.

ABC

A = Flux bin (H, J, K etc.)

B = Color bin (2, 4 etc.)

C = VF bin (D, E, F, G etc.)

Luminous Flux Bins

Table 7 lists the standard photometric luminous flux bins for LUXEON Rebel emitters (tested and binned at 350 mA using current pulse duration of 20ms).

Although several bins are outlined, product availability in a particular bin varies by production run and by product performance. Not all bins are available in all colors.

Table 7.

Flux Bins

Bin Code	Minimum Photometric Flux (lm)	Maximum Photometric Flux (lm)
H	50	60
J	60	70
K	70	80
L	80	90
M	90	100
N	100	120

Color Bin Structure

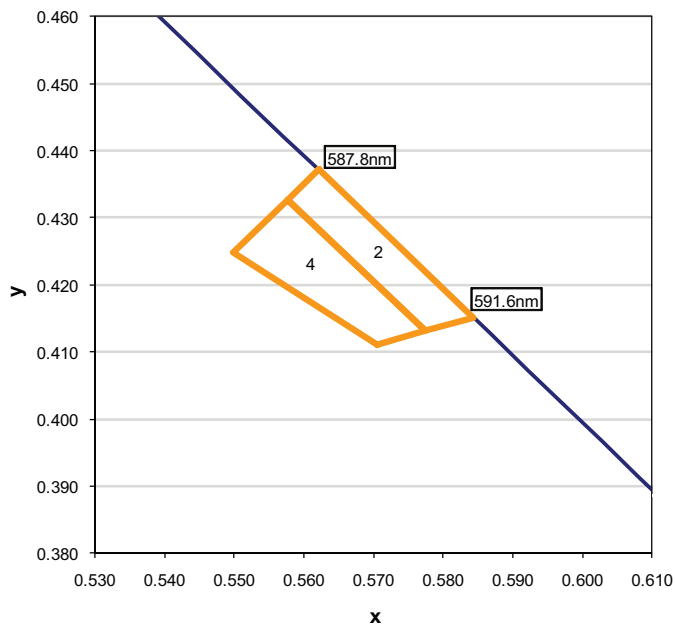

Figure 12. Color Bin Structure.

PC Amber Bin Coordinates

Table 8.

LUXEON Rebel Amber Bin Coordinates

Color Bin	x	y
2	0.5622	0.4372
	0.5576	0.4326
	0.5775	0.4132
	0.5843	0.4151
4	0.5705	0.4111
	0.5775	0.4132
	0.5576	0.4326
	0.5499	0.4249

Notes for Table 8:

1. LUXEON Rebel PC Amber Emitters are tested and binned by x,y coordinates.
2. Philips Lumileds maintains a tester tolerance of ± 0.005 on x, y color coordinates.
3. Test conditions of 350 mA with current pulse duration of 20ms.

Forward Voltage Bins

Table 9 lists minimum and maximum V_f bin values per emitter. Although several bins are outlined, product availability in a particular bin varies by production run and by product performance.

Table 9.

V_f Bins			
Bin Code	Minimum Forward Voltage (V)	Maximum Forward Voltage (V)	
B	2.55	2.79	
C	2.79	3.03	
D	3.03	3.27	
E	3.27	3.51	

Company Information

Philips Lumileds is the world's leading provider of power LEDs for everyday lighting applications. The company's records for light output, efficacy and thermal management are direct results of the ongoing commitment to advancing solid-state lighting technology and enabling lighting solutions that are more environmentally friendly, help reduce CO₂ emissions and reduce the need for power plant expansion. Philips Lumileds LUXEON® LEDs are enabling never before possible applications in outdoor lighting, shop lighting and home lighting.

Philips Lumileds is a fully integrated supplier, producing core LED material in all three base colors, (Red, Green, Blue) and white. Philips Lumileds has R&D centers in San Jose, California and in the Netherlands, and production capabilities in San Jose, Singapore and Penang Malaysia. Founded in 1999, Philips Lumileds is the high flux LED technology leader and is dedicated to bridging the gap between solid-state technology and the lighting world. More information about the company's LUXEON LED products and solid-state lighting technologies can be found at www.philipslumileds.com.

www.philipslumileds.com
www.futurelightingsolutions.com

For technical assistance or the location of your nearest sales office contact any of the following:

North America:
1 888 589 3662
americas@futurelightingsolutions.com

Europe:
00 800 443 88 873
europe@futurelightingsolutions.com

Asia Pacific:
800 5864 5337
asia@futurelightingsolutions.com

Japan:
800 5864 5337
japan@futurelightingsolutions.com

PHILIPS
LUMILEDS

©2010 Philips Lumileds Lighting Company. All rights reserved. Product specifications are subject to change without notice. LUXEON is a registered trademark of the Philips Lumileds Lighting Company in the United States and other countries.